

# MB ALUM

MB 180

Product easy to install. Possibility to easily enable or disable spring function. Easy adjustable spring strength. Endurance of more than 250.000 work cycles. Aluminum finishing in various colors. Special model for outdoor installation.

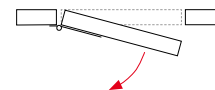

### Outside materials

- blade: anodized aluminum
- adjustable cap: zamac
- arm and flange: steel

### Inside materials

- inner axle: stainless steel AISI 304
- inner spring: steel blades set with protective grease

### Performance

- application: suitable for indoor/outdoor installation
- automatic return: yes
- adjustable return power: yes
- maximum door opening: 180°
- working cycles: up to 250.000

see MB tutorial



### Proper installation

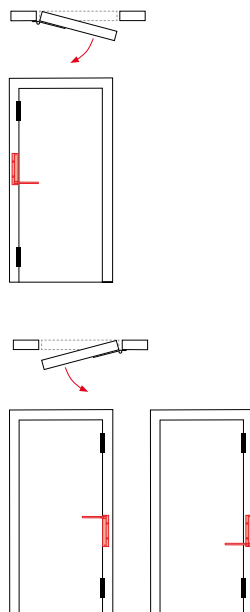

### Tension

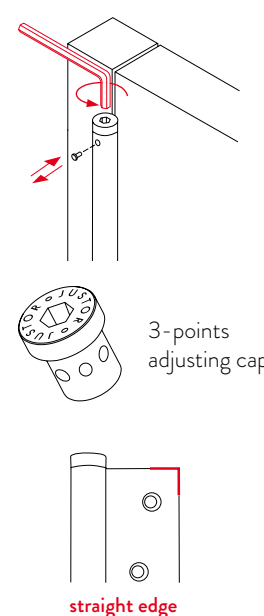

## MB 180

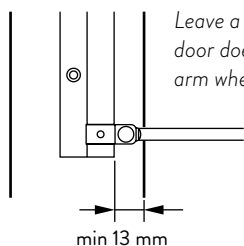
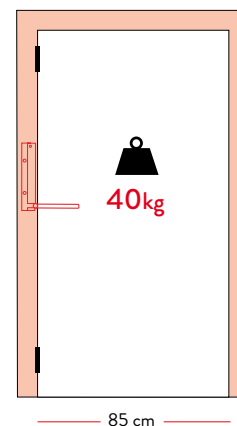
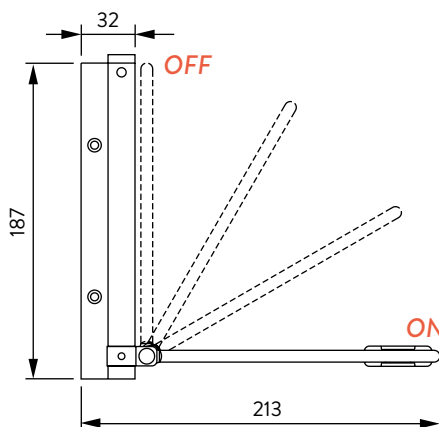
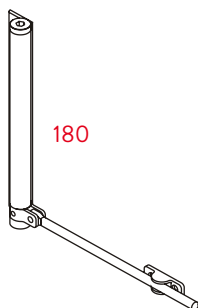

Leave a space (min. 13mm) so that the door does not interfere with the spring arm when in OFF position.

min 13 mm